

Fluorescent Recessed Housing

Fixtures are listed for insulated ceilings—Type IC, airtight—AT and for suspended ceilings—Type S. To insure safe and reliable operations, make sure the fixture corresponds to the proper ceiling installation. Read the following material carefully before beginning installation.

In general these instructions apply to “round” housings. Drawings of “round” housings have been used to illustrate installation procedures.

Before attempting installation of any recessed lighting fixture check your local electrical code. This code sets the wiring standards for your locality and should be carefully studied before starting work.

INSULATED CEILINGS - TYPE IC

Insulated Ceiling

The insulated ceiling or IC approved recessed fixture is one that can be installed in direct contact with insulation. Includes gasket to be attached between trim and housing



SUSPENDED CEILINGS - TYPE S

Fixture can be installed in suspended ceilings that are not permanent or insulated.

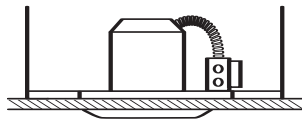

FIRE/ELECTRICAL HAZARD: INSTALL ACCORDING TO NATIONAL ELECTRIC CODE AND ANY APPLICABLE MUNICIPAL CODE REQUIREMENTS.

This equipment is intended to be installed only by qualified personnel. The installation must be made in accordance with the current edition to the National Electric Code and all applicable state and local building codes. The final installation must be approved by the appropriate qualified electrical/building inspector(s). Improper installation may result in a fire or electrical hazard. Be sure the electrical power to the circuit has been disconnected before installing this electrical system.

For ballast replacement, a qualified electrician can replace the ballast without the cutting of wires. For additional details, contact technical support at 800.686.6672.

WARNING - RISK OF FIRE:

Most dwellings built before 1985 have supply wire rated 60 degrees Celsius (thermal cutoffs in fixtures operate at 90 degrees Celsius); consult a qualified electrician prior to installation. If supply wires are located within three inches of ballast, use wire rated for at least 90°C.

A qualified electrician can replace this ballast without cutting wires. Contact technical support at 1-800-686-6672 for additional details.

TO INSTALL HOUSING:

Standard “Joist” Ceilings:

- 1) Use bar hangers to attach fixture between ceiling joists. Each end of the bar hanger is equipped with a nail-in barbed tab. Additional hardware such as screws or nails may be used if extra support is necessary.
- 2) For steel studs, use steel piercing screws in place of nails or barbed tabs.
- 3) Remove shipping screw from underneath side of plaster frame.

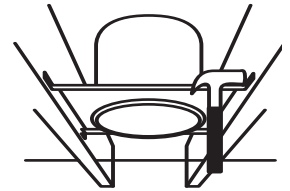

T-Bar Ceilings:

- 1) If mounting to a T-Bar type ceiling, mount fixture onto grid by placing notches on the bottom of each end of the bar hanger over the grid.
- 2) Tie fixture to grid with structural wire going through both the circular knockout on the end of the bar hanger and nearest accompanying knockout on the ceiling grid.

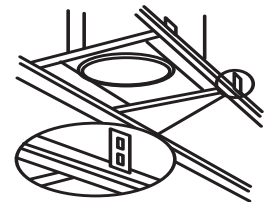

Note: It is imperative to tie down the fixture to prevent the fixture from being pushed above the ceiling during trim installation.

ELECTRICAL CONNECTIONS:

1. Connect 1/2 inch trade size steel conduit to junction box with appropriate fitting. If using Romex-type shielded wiring, use rectangular pry-out strain reliefs located on upper corners of junction box.
2. Connect -
 - Black - Supply Voltage
 - White - Neutral
 - Green Grounding J-Box Wire - Copper or green grounding wire

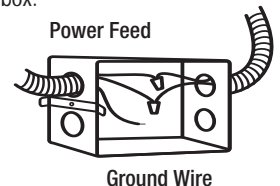

NOTE ON GROUNDING: Many structures carry grounding via steel conduit. If this is the case, if there is no grounding wire, simply leave green wire on fixture unattached. Fixture will be grounded through attachment of conduit to junction box. However, if Romex or PVC conduit is used, ground wire will always be present, and must be connected to green wire on fixture junction box to avoid electrical shock hazard.

CUTTING A HOLE:

Standard “Joist” Ceilings:

- 1) Locate the center of proposed opening on your tile or ceiling and mark it.
- 2) Use a compass to draw a circle 6-3/8" in diameter around the center point. Cut along this circular line.



Remodel Housing Installation

FIRE/ELECTRICAL HAZARD: INSTALL ACCORDING TO NATIONAL ELECTRIC CODE AND ANY APPLICABLE MUNICIPAL CODE REQUIREMENTS.

This equipment is intended to be installed only by qualified personnel. The installation must be made in accordance with the current edition to the National Electric Code and all applicable state and local building codes. The final installation must be approved by the appropriate qualified electrical/building inspector(s). Improper installation may result in a fire or electrical hazard. Be sure the electrical power to the circuit has been disconnected before installing this electrical system.

For ballast replacement, a qualified electrician can replace the ballast without the cutting of wires. For additional details, contact technical support at 800.686.6672.

WARNING - RISK OF FIRE:

Most dwellings built before 1985 have supply wire rated 60 degrees Celsius (thermal cutoffs in fixtures operate at 90 degrees Celsius); consult a qualified electrician prior to installation. If supply wires are located within three inches of ballast, use wire rated for at least 90°C.

A qualified electrician can replace this ballast without cutting wires. Contact technical support at 1-800-686-6672 for additional details.

ELECTRICAL CONNECTIONS:

1. Cut a 6-1/4" aperture (159mm) into existing sheet rock ceiling. (Fig. 1)
2. Pull conduit with line voltage, neutral, and ground leads through opening.
3. Remove junction box door.
4. Remove pryout for 1/2" or 3/4" conduit.
5. Affix conduit or junction box using appropriate connector (not included). If using Romex, simple push past cable lock - no additional connector is required.
6. Connect wiring from power source to fixture wiring:
Black - Black/Red; White - White; Green - Bare Copper/Green
Use standard connectors (not included). (Fig. 2)
7. Feed-through wiring: Other conduit paths may connect to junction box utilizing the other outlets on the junction box. Use the additional knockouts to pull through 12AWG wire, splicing to fixture wiring as noted above. Note: wiring and connections must conform to National Electric Code and all local or municipal code requirements.
8. Snap junction box door into place.

FIXTURE MOUNTING

1. To install fixture, simply insert into ceiling opening, starting with the junction box, finally pushing housing straight up into place. (Fig. 3)
2. Push ceiling springs out of fixture until flat surface of spring is flush with interior of housing.
3. Using a screwdriver, force the small tab at the top of the spring up and as tightly as possible against the housing wall to lock fixture into place. (Fig. 4)

(Fig. 1)

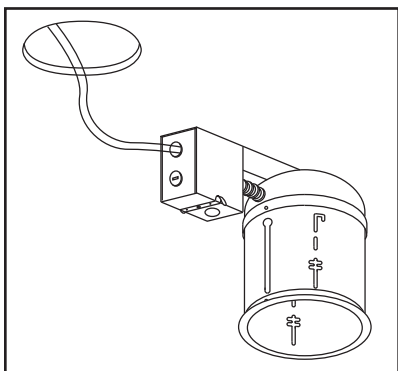

(Fig. 2)

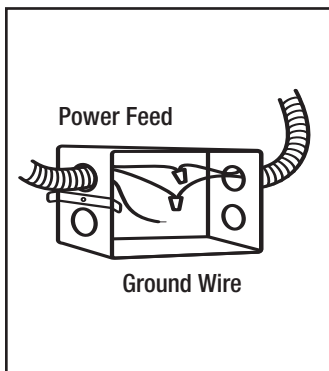

(Fig. 3)

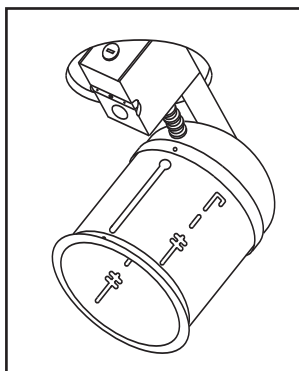

(Fig. 4)

